

WLAN Bluetooth PCI Express Adapter

Images may differ from your actual product.

Before You Start:
If you plan on using Bluetooth and already have connected Bluetooth devices, proceed with step 1. Otherwise, skip to step 2.

1 Disable Bluetooth

- Right-click **My Computer**, select **Manage**, go to **Device Manager**.
- Expand the **Bluetooth** node to find your existing Bluetooth device.
- Right-click the existing Bluetooth device and select **Disable**.

Note:
Make sure you have disabled all existing Bluetooth devices (both built-in and third party).

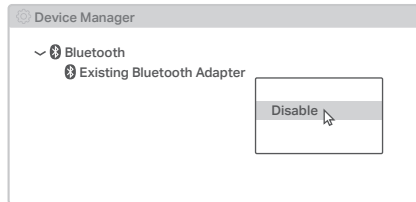

2 Connect to a Computer

- Turn off your computer, unplug the power cable then remove the case panel.
- Connect the provided Bluetooth USB cable to the adapter.

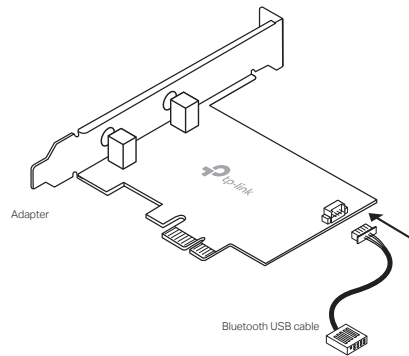

- Locate an available **PCIE slot (X1, X4 or X16)** and carefully insert the adapter.

Note:
If the bracket is not suitable for your computer, detach it from the adapter's board and replace it with the low-profile bracket.

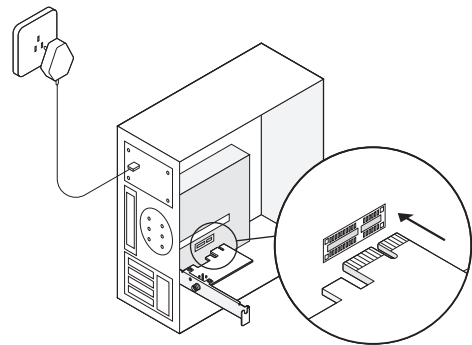

- Locate an available **F_USB connector** and carefully plug the Bluetooth USB cable into it.

Note:
If the Bluetooth USB cable is not correctly connected to the motherboard, Bluetooth function won't work even after driver installation.

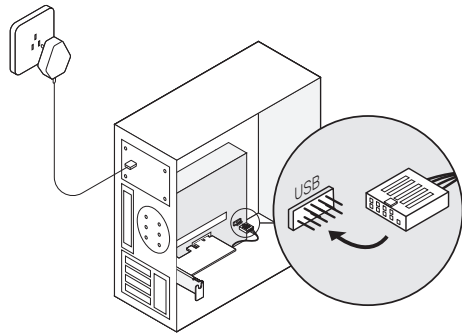

To continue, flip the page over.

e. Connect the antenna(s) to the adapter.

Tip:

To maximize performance, make sure the path between the antenna(s) and your router is clear.

f. Replace the case panel, plug in the power cable and turn on your computer.

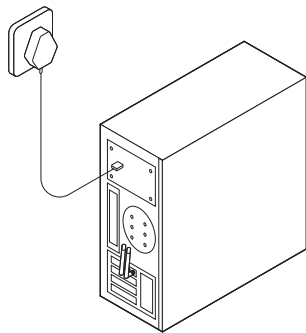



3 Install Drivers

a. Insert the CD and run the **Autorun.exe**.

Tip: You can also check the new release and download the driver at <https://www.tp-link.com/support/download/>

b. Install the Wi-Fi and Bluetooth drivers.

① **Wi-Fi:** Click  and follow the onscreen instructions to complete the Wi-Fi installation.

② **Bluetooth:** Click  and follow the onscreen instructions to complete the Bluetooth installation.

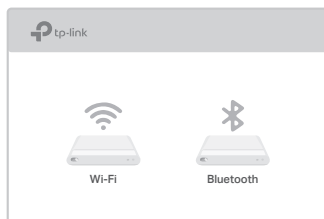

Notes:

- If an unknown publisher message pops up, select **Yes** to continue.
- If Windows User Account Control requires admin credentials, type user name and password of your Windows administrator account.

4 Join a Wireless Network

a. Click the network icon () on the taskbar.

b. Select your Wi-Fi network, click **Connect**, and enter the password when prompted.

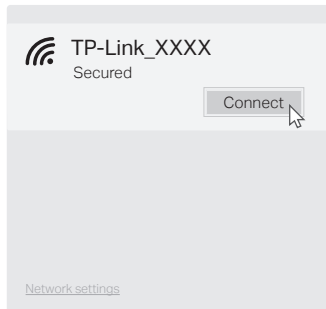

5 Pair With Bluetooth Devices

a. Right click the  (Bluetooth) icon on the taskbar. If it's not displayed, turn on Bluetooth in your PC settings first.

b. Select **Add a Bluetooth Device** or **Add a Device** to scan for available devices.

c. Select your Bluetooth device from the list and follow the onscreen instructions to complete pairing.

Note:

Make sure your device's Bluetooth is enabled and discoverable.

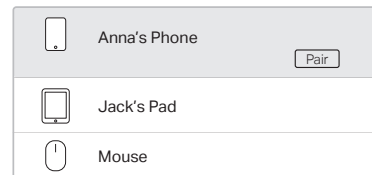

Support

For technical support, the user guide and other information, simply scan the QR code or visit <https://www.tp-link.com/support/>



To communicate with TP-Link users or engineers, please visit <https://community.tp-link.com> to join TP-Link Community.

Safety Information

- Keep the device away from water, fire, humidity or hot environments.
- Do not attempt to disassemble, repair, or modify the device. If you need service, please contact us.
- Do not use the device where wireless devices are not allowed.